



SPLIT TYPE AIR CONDITIONER SIRIUS

INSTALLATION MANUAL



This instruction manual contains important information and recommendations that we would ask you to comply with to obtain best results from air conditioner.

Thank you once again.

CONTENTS

SAFETY PRECAUTIONS	1
NAMES OF PARTS	4
INDOOR UNIT DISPLAY	5
EMERGENCY FUNCTION & AUTO-RESTART FUNCTION	6
REMOTE CONTROLLER	7
OPERATING INSTRUCTIONS	12
INSTALLATION MANUAL.....	18
MAINTENANCE	31
TROUBLESHOOTING	32
INSTRUCTION FOR SERVERING.....	33

In line with the company's policy of continual product improvement, the aesthetic and dimensional characteristics, technical data and accessories of this appliance may be changed without notice.

SAFETY RULES AND RECOMMENDATIONS FOR THE INSTALLER

⚠ Read this guide before installing and using the appliance.

⚠ During the installation of the indoor and outdoor units the access to the working area should be forbidden to children. Unforeseeable accidents could happen.

⚠ Make sure that the base of the outdoor unit is firmly fixed.

⚠ Check that air cannot enter the refrigerant system and check for refrigerant leaks when moving the air conditioner.

⚠ Carry out a test cycle after installing the air conditioner and record the operating data.

⚠ The ratings of the fuse installed in the built in control unit are 4A / 250V .

⚠ Protect the indoor unit with a fuse of suitable capacity for the maximum input current or with another overload protection device.

⚠ Ensure that the mains voltage corresponds to that stamped on the rating plate. Keep the switch or power plug clean. Insert the power plug correctly and firmly into the socket, thereby avoiding the risk of electric shock or fire due to insufficient contact.

⚠ Check that the socket is suitable for the plug , otherwise have the socket changed.

⚠ The appliance must be fitted with means for disconnection from the supply mains having a contact separation in all poles that provide full disconnection under overvoltage category III conditions, and these means must be incorporated in the fixed wiring in accordance with the wiring rules.

⚠ The air conditioner must be installed by professional or qualified persons.

⚠ Do not install the appliance at a distance of less than 50 cm from inflammable substances (alcohol, etc.) or from pressurised containers (e.g. spray cans).

⚠ If the appliance is used in areas without the possibility of ventilation, precautions must be taken to prevent any leaks of refrigerant gas from remaining in the environment and creating a danger of fire

⚠ The packaging materials are recyclable and should be disposed of in the separate waste bins .Take the air conditioner at the end of its useful life to a special waste collection centre for disposal.

⚠ Only use the air conditioner as instructed in this booklet. These instructions are not intended to cover every possible condition and situation . As with any electrical household appliance , common sense and caution are therefore always recommended for installation, operation and maintenance.

⚠ The appliance must be installed in accordance with applicable national regulations.

⚠ Before accessing the terminals , all the power circuits must be disconnected from the power supply.

⚠ The appliance shall be installed in accordance with national wiring regulations.

⚠ This appliance can be used by children aged from 8 years and above and persons with reduced physical, sensory or mental capabilities or lack of experience and knowledge if they have been given supervision or instruction concerning use of the appliance in a safe way and understand the hazards involved. Children shall not play with the appliance. Cleaning and user maintenance shall not be made by children without supervision.

SAFETY RULES AND RECOMMENDATIONS FOR THE USER

⚠ Do not try to install the conditioner alone; always contact specialized technical personnel.

⚠ Cleaning and maintenance must be carried out by specialized technical personnel. In any case disconnect the appliance from the mains electricity supply before carrying out any cleaning or maintenance.

⚠ Ensure that the mains voltage corresponds to that stamped on the rating plate. Keep the switch or power plug clean. Insert the power plug correctly and firmly into the socket, thereby avoiding the risk of electric shock or fire due to insufficient contact.

⚠ Do not pull out the plug to switch off the appliance when it is in operation, since this could create a spark and cause a fire, etc.

⚠ This appliance has been made for air conditioning domestic environments and must not be used for any other purpose, such as for drying clothes, cooling food, etc.

⚠ The packaging materials are recyclable and should be disposed of in the separate waste bins. Take the air conditioner at the end of its useful life to a special waste collection center for disposal.

⚠ Always use the appliance with the air filter mounted. The use of the conditioner without air filter could cause an excessive accumulation of dust or waste on the inner parts of the device with possible subsequent failures.

⚠ The user is responsible for having the appliance installed by a qualified technician, who must check that it is earthed in accordance with current legislation and insert a thermomagnetic circuit breaker.

⚠ The batteries in remote controller must be recycled or disposed of properly.
Disposal of Scrap Batteries --- Please discard the batteries as sorted municipal waste at the accessible collection point.

⚠ Never remain directly exposed to the flow of cold air for a long time. The direct and prolonged exposition to cold air could be dangerous for your health. Particular care should be taken in the rooms where there are children, old or sick people.

⚠ If the appliance gives off smoke or there is a smell of burning, immediately cut off the power supply and contact the Service Centre.

⚠ The prolonged use of the device in such conditions could cause fire or electrocution.

⚠ Have repairs carried out only by an authorised Service Centre of the manufacturer. Incorrect repair could expose the user to the risk of electric shock, etc.

⚠ Unhook the automatic switch if you foresee not to use the device for a long time. The airflow direction must be properly adjusted.

⚠ The flaps must be directed downwards in the heating mode and upwards in the cooling mode.

⚠ Only use the air conditioner as instructed in this booklet. These instructions are not intended to cover every possible condition and situation. As with any electrical household appliance, common sense and caution are therefore always recommended for installation, operation and maintenance.

⚠ Ensure that the appliance is disconnected from the power supply when it will remain inoperative for a long period and before carrying out any cleaning or maintenance.

⚠ Selecting the most suitable temperature can prevent damage to the appliance.

SAFETY RULES AND PROHIBITIONS

- ⊖ Do not bend , tug or compress the power cord since this could damage it. Electrical shocks or fire are probably due to a damaged power cord. Specialized technical personnel only must replace a damaged power cord.
 - ⊖ Do not use extensions or gang modules.
 - ⊖ Do not touch the appliance when barefoot or parts of the body are wet or damp.
 - ⊖ Do not obstruct the air inlet or outlet of the indoor or the outdoor unit.
The obstruction of these openings causes a reduction in the operative efficiency of the conditioner with possible consequent failures or damages.
 - ⊖ In no way alter the characteristics of the appliance.
 - ⊖ Do not install the appliance in environments where the air could contain gas , oil or sulphur or near sources of heat.
 - ⊖ This appliance is not intended for use by persons (including children) with reduced physical, sensory or mental capabilities, or lack of experience and knowledge, unless they have been given supervision or instruction concerning use of the appliance by a person responsible for their safety.
- ⊖ Do not climb onto or place any heavy or hot objects on top of the appliance.
 - ⊖ Do not leave windows or doors open for long when the air conditioner is operating.
 - ⊖ Do not direct the airflow onto plants or animals.
 - ⊖ A long direct exposition to the flow of cold air of the conditioner could have negative effects on plants and animals.
 - ⊖ Do not put the conditioner in contact with water.
The electrical insulation could be damaged and thus causing electrocution.
 - ⊖ Do not climb onto or place any objects on the outdoor unit
 - ⊖ Never insert a stick or similar object into the appliance. It could cause injury.
 - ⊖ Children should be supervised to ensure that they do not play with the appliance. If the supply cord is damaged, it must be replaced by the manufacturer, its service agent or similarly qualified persons in order to avoid a hazard.

NAMES OF PARTS

INDOOR UNIT

No.	Description
1	Front panel
2	Air filter
3	Optional filter (if installed)
4	LED Display
5	Signal receiver
6	Terminal block cover
7	Ionizer generator(if installed)
8	Deflectors
9	Emergency button
10	Indoor unit rating label (Stick position optional)
11	Airflow direction louver
12	Remote controller

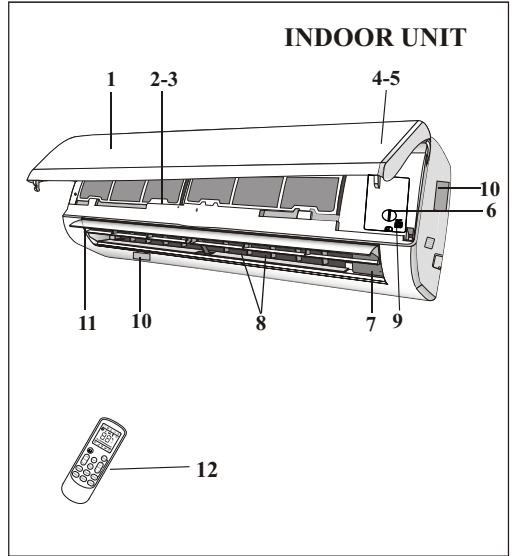

OUTDOOR UNIT

No.	Description
13	Air outlet grille
14	Outdoor unit rating label
15	Terminal block cover
16	Gas valve
17	Liquid valve

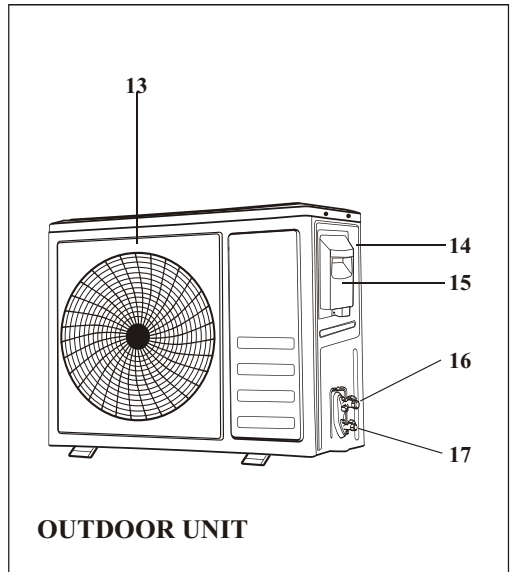





OUTDOOR UNIT

Note: The above figures are only intended to be a simple diagram of the appliance and may not correspond to the appearance of the units that have been purchased.

INDOOR UNIT DISPLAY



No.	Led		Function
1	SLEEP		SLEEP mode
2	Temperature display (if present) /Error code		(1) Lights up during Timer operation when the air conditioner is operational (2) Displays the malfunction code when fault occurs.
3	TIMER		Lights up during Timer operation.

 *The shape and position of switches and indicators may be different according to the model, but their function is the same.*

EMERGENCY FUNCTION & AUTO-RESTART FUNCTION

EMERGENCY FUNCTION

If the remote controller fails to work or maintenance necessary, proceed as following:

Open and lift the front panel up to an angle to reach the emergency button.

For heating model, press the emergency button at first time, the unit will operate in COOL mode. Press at second time within 3 seconds, the unit will operate in HEAT mode. Press at third time after 5 seconds, the unit will turn off.

For cooling only model, press the emergency button at first time, the unit will operate in COOL mode. Press again, the unit will turn off.

AUTO-RESTART FUNCTION

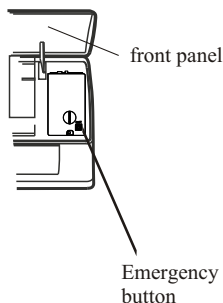

The appliance is preset with an auto-restart function. In case of a sudden power failure, the module will memorizes the setting conditions before the power failure. When the power restores, the unit will restart automatically with the previous settings preserved by the memory function.





The emergency button is located on E-box cover of the unit under the front panel.

 *The shape and position of the emergency button may be different according to the model, but their function is the same.*

REMOTE CONTROLLER

No.	Button	Function
1		To turn on/ off the air conditioner.
2	∨	To decrease the set room temperature, reduce the time when set TIMER.
3	∧	To increase the set room temperature, lengthen the time when set TIMER.
4	MODE	To select the operating mode: AUTO, COOLING, DRY, FAN, HEATING.
5	ECO	To switch on/off the ECO function(energy saving) .
6	TURBO	To switch on/off the TURBO function which enable the unit to reach the preset temperature in the short time.
7	FAN	To select the fan speed of indoor unit:auto, low, mid, high.
8	TIMER	To switch on/off the TIMER function.
9	SLEEP	To switch on/off the SLEEP function.
10	DISPLAY	To turn on/off the indoor display.
11	SWING < >	To set the air flow direction left and right(if applicable).
12	SWING 	To set the air flow direction up and down.
13	MUTE	To switch on/off the MUTE function.
14	I FEEL	To switch on/off the I FEEL function.
15		Press Mode and Timer together to lock the buttons of remote controller.

 *The display and some functions of the remote control may vary according to the model.*

 *The shape and position of buttons and indicators may vary according to the model, but their function is the same.*

 *The unit confirms the correct reception of each button with a beep.*

 *You will hear a beep when you press the button Swing < >, though the actual model haven't this function, we express our apologies.*

REMOTE CONTROLLER

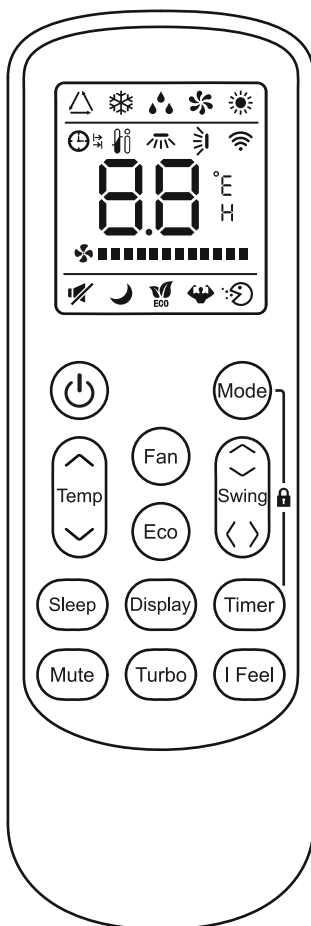



















 *You will hear a beep when you press the button Swing <>, though the actual model haven't this function, we express our apologies.*

REMOTE CONTROLLER

Remote controller DISPLAY

Meaning of symbols on the liquid crystal display

No.	Symbols	Meaning
1		Mode AUTO
2		Mode COOLING
3		Mode DRY
4		Mode FAN
5		Mode HEATING
6		Timer on
7		Timer off
8		I FEEL function
9		Left-right auto swing
10		Up-down auto swing
11		Temperature or time indicator
12	 <i>flashing</i>	Fan speed Auto
13		Fan speed Low
14		Fan speed Mid
15		Fan speed High
16		MUTE function
17		SLEEP function
18		ECO function
19		TURBO function

REMOTE CONTROLLER

Replacement of Batteries

Remove the battery cover plate from the rear of the remote control, by sliding it in the direction of the arrow. Install the batteries according the direction (+and -)shown on the Remote Control. Reinstall the battery cover by sliding it into place.

- ⚠ Use 2 LRO 3 AAA (1.5V) batteries. Do not use rechargeable batteries.
Replace the old batteries with new ones of the same type when the display is no longer legible.
Do not dispose batteries as unsorted municipal waste.
Collection of such waste separately for special treatment is necessary.

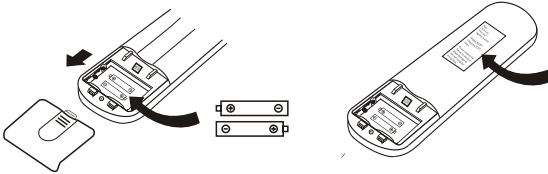

Note
Please remove batteries to avoid leakage damage when not using for a long time.

- ⚠ For some model of remote controller, open the battery cover, and you can see the manual switch at the bottom, then you can select the Cooling only or Heating pump, operate as below,

DIP switch on position	Function
°C	The display is adjusted in degree celsius
°F	The display is adjusted in degree fahrenheit.
Cool	The display is adjusted in only cooling mode
Heat	The display is adjusted in cooling and heating mode

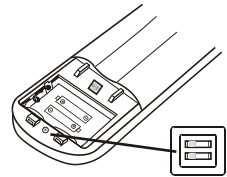

- ⚠
1. Direct the remote control toward the Air conditioner.
 2. Check that there are no objects between the remote control and the Signal receptor in the indoor unit.
 3. Never leave the remote control exposed to the rays of the sun.
 4. Keep the remote control at a distance of at least 1m from the television or other electrical appliances.

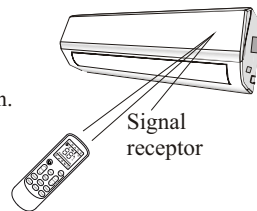

OPERATING INSTRUCTIONS

The air sucked by the fan enters from the grill and passes through the filter, then it is cooled/dehumidified or heated through the heat exchanger.

The direction of the air outlet is motorized up and down by flaps, and manually moved right and left by the vertical deflectors, for some models, the vertical deflectors could be controlled by motor as well.

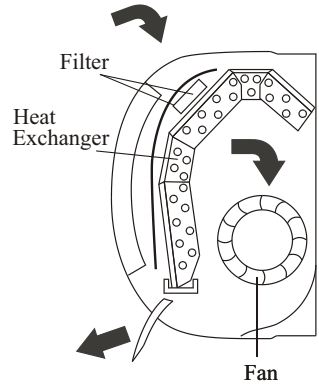

“SWING” CONTROL OF THE AIR FLOW

1. Press the button SWING to activate the louver,
 - (1) Press to activate the horizontal flaps to swing from up to down. Press again to stop the swing movement at the current angle.
 - (2) Press to activate the vertical deflectors to swing from left to right. Press again to stop the swing movement at the current angle.
2. If the vertical deflectors are positioned manually which placed under the flaps, they allow to move the air flow direct to rightward or leftward.

- This adjustment must be done while the appliance is switched off.
- Never position “Flaps” manually, the delicate mechanism might seriously damaged!
- Never poke fingers, sticks or other objects in the air inlet or outlet vents. Such accidental contact with live parts might cause unforeseeable damage or injury.

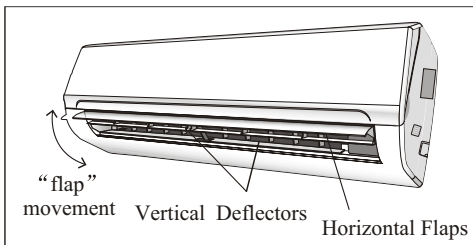
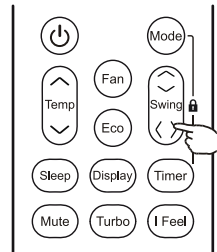



OPERATING INSTRUCTIONS

COOLING MODE



The cooling function allows the air conditioner to cool the room and at the same time reduces Air humidity.

To activate the cooling function (COOL) , press the **MODE** button until the symbol  appears on the display.

With the button  or  set a temperature lower than that of the room.

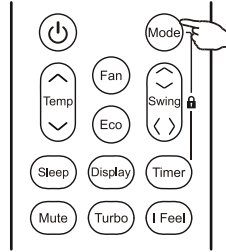



HEATING MODE



The heating function allows the air conditioner to heat the room.

To activate the heating function (HEAT) , press the **MODE** button until the symbol  appears on the display.

With the button  or  set a temperature higher than that of the room.



In HEATING operation, the appliance can automatically activate a defrost cycle, which is essential to clean the frost on the condenser so as to recover its heat exchange function. This procedure usually lasts for 2-10 minutes. During defrosting, indoor unit fan stop operation. After defrosting, it resumes to HEATING mode automatically.

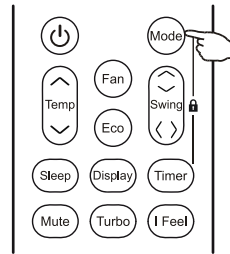

DRY MODE



This function reduces the humidity of the air to make the room more comfortable.

To set the DRY mode , Press **MODE** until  appears in the display. An automatic function of pre-setting is activated.

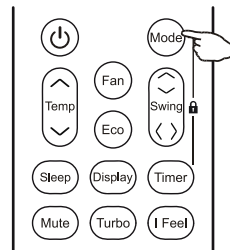

OPERATING INSTRUCTIONS

FAN MODE(Not FAN button)



Fan mode, air ventilation only.

To set the FAN mode, press **MODE** until  appears on the display.

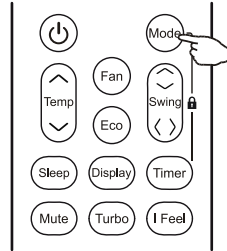

AUTO MODE



Automatic mode.

To set the AUTO mode, press **MODE** until  appears on the display.

In AUTO mode the run mode will be set automatically according to the room temperature.

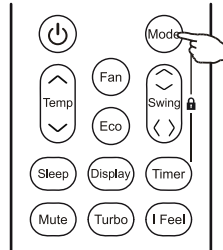

DISPLAY function (Indoor display)

DISPLAY

Turn on/off the indoor display.

Press **DISPLAY** button to switch off the LED display on the panel. Press again to switch on the LED display.

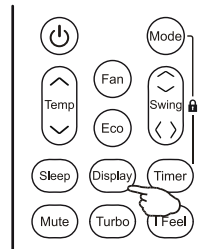

OPERATING INSTRUCTIONS

ECO function



In this mode the appliance automatically sets the operation to save energy.

Press the **ECO** button, the  appears on the display, and the appliance will run in ECO mode. Press again to cancel it..

NOTE:

The ECO function is available in both COOLING and HEATING modes.

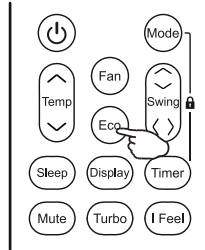

Turbo function



To activate turbo function, press the **TURBO** button, and  will appear on the display. Press again to cancel this function.

In COOL/HEAT mode, when you select TURBO feature, the appliance will operate the highest fan setting to blow the strong airflow.

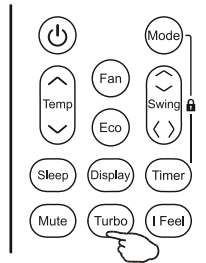

SLEEP function



Pre-setting automatic operating program.

Press **SLEEP** button to activate the SLEEP function, and  appears on the display. Press again to cancel this function.

After 10 hours running in sleep mode, the air conditioner will change to the previous setting mode.

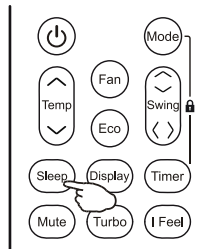

OPERATING INSTRUCTIONS

FAN function (FAN button)

FAN

Change the operating fan speed.

Press **FAN** button to set the running fan speed, it can be set to AUTO/LOW/MID/HIGH speed.

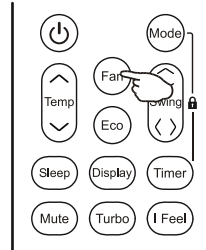

MUTE function (Optional)

MUTE

1. Press **MUTE** button to activate this function, and  will appear on the remote display. Do it again to deactivate this function.
2. When the MUTE function runs, the remote controller will display the auto fan speed, and the indoor unit will operate at lowest fan speed to be quiet feeling.
3. When press FAN/TURBO/SLEEP button, the MUTE function will be cancel. MUTE function can not be activated under dry mode.

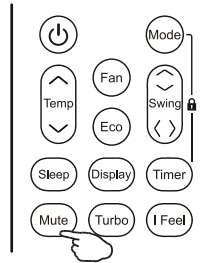

I FEEL function (Optional)

I FEEL

Press **I FEEL** button to activate the function, the  will appear on the remote display. Do it again to deactivate this function.

This function enables the remote control to measure the temperature at its current location, and send this signal to the air conditioner to optimize the temperature around you and ensure the comfort. It will automatically deactivate 2 hours later.

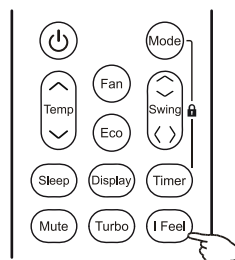

OPERATING INSTRUCTIONS

TIMER function ---- TIMER ON

TIMER

To automatic switch on the appliance.

When the unit is switch-off, you can set the TIMER ON.

To set the time of automatic switch-on, as below:

1. Confirm the appliance is OFF. And press the **TIMER** button at first time to set the needed mode and fan speed, the  will appear on the display.
2. Set the needed mode(Cool/Heat/Auto/Fan/Dry), by press the **MODE** button. And set the needed fan speed, by press **FAN** button. And press \wedge or \vee to set the needed operation temperature.
3. Press **TIMER** button at the second time to set the switch-on. Press \wedge or \vee to set the needed timer.
4. Press **TIMER** button at the third time to confirm.

CANCEL it by press **TIMER** button.

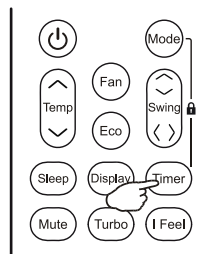

Figure1,Timer-on when switch off

TIMER function ---- TIMER OFF

TIMER

To automatic switch off the appliance.

When the unit is switch-on, you can set the TIMER OFF.

To set the time of automatic switch-off, as below:

1. Confirm the appliance is ON.
2. Press the **TIMER** button at first time to set the switch-off. Press \wedge or \vee to set the needed timer.
3. Press **TIMER** button at the second time to confirm.

CANCEL it by press **TIMER** button.

Note:

All programming should be operated within 5 seconds, otherwise the setting will be cancelled.

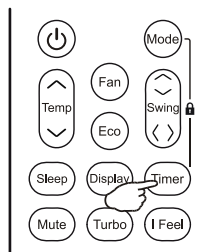

Figure2,Timer-off when switch on

OPERATING INSTRUCTIONS

Operating Temperature

The air conditioner is programmed for comfortable and suitable living conditions as below if used outside the conditions, certain safety protection features might come into effect.,

Fix air conditioner:

MODE Temperature	Cooling operating	Heating operating	Drying operating
Room temperature	17°C~32°C	0°C~27°C	17°C~32°C
Outdoor temperature	15°C~43°C For T1 Climate	-7°C~24°C	15°C~43°C For T1 Climate
	15°C~52°C For T3 Climate		15°C~52°C For T3 Climate

Inverter air conditioner:

MODE Temperature	Cooling operating	Heating operating	Drying operating
Room temperature	17°C~32°C	0°C~30°C	17°C~32°C
Outdoor temperature	15°C~53°C	-20°C~30°C	15°C~53°C
	-15°C~53°C For models with low temperature cooling system		-15°C~53°C For models with low temperature cooling system

 *The unit does not operate immediately if it is turned on after being turned off or after changing the mode during operation. This is a normal self-protection action, you need waiting for about 3 minutes.*

 *The capacity and efficiency are according to the test conducted at full-load operation (The highest speed of indoor fan motor and the maximum open angle of the flaps and deflectors are requested.)*

■ Important Considerations

- The air conditioner you buy must be installed by professional personnel and the “Installation manual” is used only for the professional installation personnel! The installation specifications should be subject to our after-sale service regulations.
- When filling the combustible refrigerant, any of your rude operations may cause serious injury or injuries to human body or bodies and object or objects.
- A leak test must be done after the installation is completed.
- It is a must to do the safety inspection before maintaining or repairing an air conditioner using combustible refrigerant in order to ensure that the fire risk is reduced to minimum.
- It is necessary to operate the machine under a controlled procedure in order to ensure that any risk arising from the combustible gas or vapor during the operation is reduced to minimum.
- Requirements for the total weight of filled refrigerant and the area of a room to be equipped with an air conditioner (are shown as in the following Tables GG.1 and GG.2)



INSTALLATION MANUAL---Important considerations

■ The maximum charge and the required minimum floor area

$$m_1 = (4 \text{ m}^3) \times LFL, m_2 = (26 \text{ m}^3) \times LFL, m_3 = (130 \text{ m}^3) \times LFL$$

Where *LFL* is the lower flammable limit in kg/m³, R290 LFL is 0.038 kg/m³, R32 LFL is 0.038 kg/m³.

For the appliances with a charge amount $m_1 < M = m_2$:

The maximum charge in a room shall be in accordance with the following: $m_{\max} = 2.5 \times (LFL)^{(5/4)} \times h_0 \times A^{1/2}$

The required minimum floor area *A*_{min} to install an appliance with refrigerant charge *M* (kg) shall be in accordance with following: $A_{\min} = (M / (2.5 \times (LFL)^{(5/4)} \times h_0))^2$

Where:

*m*_{max} is the allowable maximum charge in a room, in kg;

M is the refrigerant charge amount in appliance, in kg;

*A*_{min} is the required minimum room area, in m²;

A is the room area, in m²;

LFL is the lower flammable limit, in kg/m³;

*h*₀ is the installation height of the appliance, in meters for calculating *m*_{max} or *A*_{min}, 1.8 m for wall mounted;

Table GG.1 - Maximum charge (kg)

Category	LFL (kg/m ³)	h ₀ (m)	Floor area (m ²)						
			4	7	10	15	20	30	50
R290	0.038	0.6	0.05	0.07	0.08	0.1	0.11	0.14	0.18
		1	0.08	0.11	0.13	0.16	0.19	0.2	0.3
		1.8	0.15	0.2	0.24	0.29	0.34	0.41	0.53
		2.2	0.18	0.24	0.29	0.36	0.41	0.51	0.65
R32	0.306	0.6	0.68	0.9	1.08	0.32	1.53	1.87	2.41
		1	1.14	1.51	1.8	2.2	2.54	3.12	4.02
		1.8	2.05	2.71	3.24	3.97	4.58	5.61	7.254
		2.2	2.5	3.31	3.96	4.85	5.6	6.86	8.85

Table GG.2 - Minimum room area (m²)

Category	LFL (kg/m ³)	h ₀ (m)	Charge amount (M) (kg)						
			Minimum room area (m ²)						
R290	0.038		0.152kg	0.228kg	0.304kg	0.456kg	0.608kg	0.76kg	0.988kg
		0.6		82	146	328	584	912	1514
		1		30	53	118	210	328	555
		1.8		9	16	36	65	101	171
		2.2		6	11	24	43	68	115
R32	0.306		1.224kg	1.836kg	2.448kg	3.672kg	4.896kg	6.12kg	7.956kg
		0.6		29	51	116	206	321	543
		1		10	19	42	74	116	196
		1.8		3	6	13	23	36	60
		2.2		2	4	9	15	24	40

■ Installation Safety Principles

1. Site Safety



Open Flames Prohibited



Ventilation Necessary

2. Operation Safety

Open Flames Prohibited



Mind Static Electricity



Must wear protective clothing and anti-static gloves



Don't use mobile phone

3. Installation Safety

- Refrigerant Leak Detector
- Appropriate Installation Location



The left picture is the schematic diagram of a refrigerant leak detector.

Please note that:

1. The installation site should be in a well-ventilated condition.
2. The sites for installing and maintaining an air conditioner using Refrigerant R290 should be free from open fire or welding, smoking, drying oven or any other heat source higher than 370°C which easily produces open fire; the sites for installing and maintaining an air conditioner using Refrigerant R32 should be free from open fire or welding, smoking, drying oven or any other heat source higher than 548°C which easily produces open fire.
3. When installing an air conditioner, it is necessary to take appropriate anti-static measures such as wear anti-static clothing and/or gloves.
4. It is necessary to choose the site convenient for installation or maintenance wherein the air inlets and outlets of the indoor and outdoor units should be not surrounded by obstacles or close to any heat source or combustible and/or explosive environment.
5. If the indoor unit suffers refrigerant leak during the installation, it is necessary to immediately turn off the valve of the outdoor unit and all the personnel should go out till the refrigerant leaks completely for 15 minutes. If the product is damaged, it is a must to carry such damaged product back to the maintenance station and it is prohibited to weld the refrigerant pipe or conduct other operations on the user's site.
6. It is necessary to choose the place where the inlet and outlet air of the indoor unit is even.
7. It is necessary to avoid the places where there are other electrical products, power switch plugs and sockets, kitchen cabinet, bed, sofa and other valuables right under the lines on two sides of the indoor unit.

INSTALLATION MANUAL---Important considerations

■ Special Tools

Tool Name	Requirement(s) for Use
Mini Vacuum Pump	It should be an explosion-proof vacuum pump; can ensure certain precision and its vacuum degree should be lower than 10Pa.
Filling Device	It should be a special explosion-proof filling device; have certain precision and its filling deviation should be less than 5g.
Leak Detector	It should be calibrated regularly; and its annual leak rate should not exceed 10g.
Concentration Detector	<p>A) The maintenance site should be equipped with a fixed-type combustible refrigerant concentration detector and connected to a safeguard alarm system; its error must be not more than 5%.</p> <p>B) The installation site should be equipped with a portable combustible refrigerant concentration detector which can realize two-level audible and visual alarm; its error must be not more than 10%.</p> <p>C) The concentration detectors should be calibrated regularly.</p> <p>D) It is necessary to check and confirm the functions before using the concentration detectors.</p>
Pressure Gauge	<p>A) The pressure gauges should be calibrated regularly.</p> <p>B) The pressure gauge used for Refrigerant 22 can be used for Refrigerants R290 and R161; the pressure gauge used for R410A can be used for Refrigerant 32.</p>
Fire Extinguisher	It is necessary to carry fire extinguisher(s) when installing and maintaining an air conditioner. On the maintenance site, there should be two or more kinds of dry powder, carbon dioxide and foam fire extinguishers and that such fire extinguishers should be placed at stipulated positions, with eye-catching labels and in handy places.

INSTALLATION MANUAL---Selecting the Installation Place

INDOOR UNIT

- Install the indoor unit on a strong wall that is not subject to vibrations.
- The in let and outlet ports should not be obstructed:the air should be able to blow all over the room.
- Do not install the unit near a source of heat , steam, or flammable gas.
- Do not install the unit where it will be exposed to direct sunlight.
- Select a site where the condensed water can be easily drained out, and where it is easily connected to outdoor unit.
- Check the machine operation regularly and reserve the necessary spaces as shown in the picture.
- Select a place where the filter can be easily taken out.

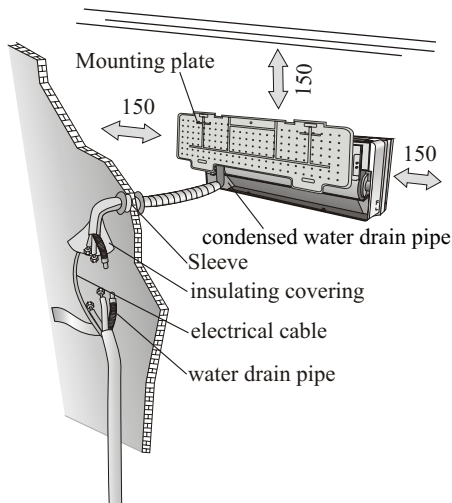

OUTDOOR UNIT

- Do not install the outdoor unit near sources of heat, steam or flammable gas.
- Do not install the unit in too windy or dusty places.
- Do not install the unit where people often pass. Select a place where the air discharge and operating sound will not disturb the neighbours.
- Avoid installing the unit where it will be exposed to direct sunlight (other wise use a protection , if necessary, that should not interfere with the air flow).
- Reserve the spaces as shown in the picture for the air to circulate freely.
- Install the outdoor unit in a safe and solid place.
- If the outdoor unit is subject to vibration, place rubber gaskets onto the feet of the unit..

minimum space to be reserved (mm) showing in the picture

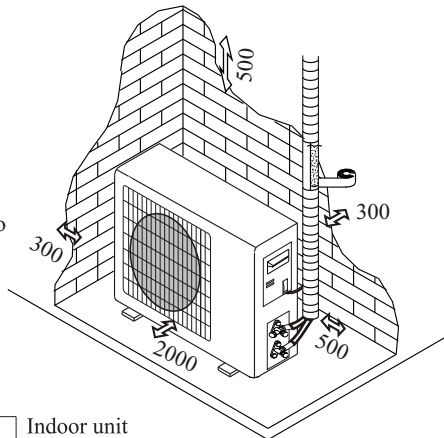

Installation Diagram

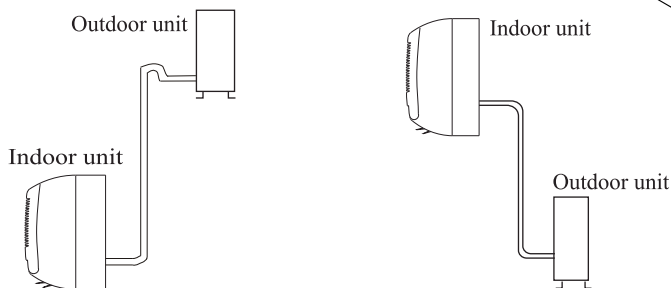

The purchaser must ensure that the person and/or company who is to install, maintain or repair this air conditioner has qualifications and experience in refrigerant products.

INSTALLATION MANUAL---Installation of the Indoor unit

Before starting installation, decide on the position of the indoor and outdoor units, taking into account the minimum space reserved around the units

⚠ Do not install your air conditioner in a wet room such as a bathroom or laundry etc

⚠ The installation site should be 250cm or more above the floor.

To install, proceed as follows:

Installation of the mounting plate

- 1 Always mount the rear panel horizontally and vertically
2. Drill 32 mm deep holes in the wall to fix the plate;
3. Insert the plastic anchors into the hole;
4. Fix the rear panel on the wall with provided tapping screws
5. Be sure that the rear panel has been fixed firmly enough to withstand the weight

Note : The shape of the mounting plate may be different from the one above, but installation method is similar .

Drilling a hole in the wall for the piping

1. Make the piping hole ($\Phi 65$) in the wall at a slight downward slant to the outdoor side.
2. Insert the piping-hole sleeve into the hole to prevent the connection piping and wiring from being damaged when passing through the hole.

⚠ The hole must slope downwards towards the exterior

Note : Keep the drain pipe down towards the direction of the wall hole, otherwise leakage may occur.

Electrical connections---Indoor unit

1. Open the front panel.
 2. Take off the cover as indicated in the picture (by removing a screw or breaking the hooks).
 3. For the electrical connections, see the circuit diagram on the right part of the unit under the front panel.
 4. Connect the cable wires to the screw terminals by following the numbering ,Use wire size suitable to the electric power input (see name plate on the unit) and according to all current national safety code requirements.
- ⚠ The cable connecting the outdoor and indoor units must be suitable for outdoor use.
- ⚠ The plug must be accessible also after the appliance has been installed so that it can be pulled out if necessary.
- ⚠ An efficient earth connection must be ensured.
- ⚠ If the power cable is damaged, it must be replaced by an authorised Service Centre.

Note: Optional the wires can be connected to the main PCB of indoor unit by manufacturer according to the model without terminal block.

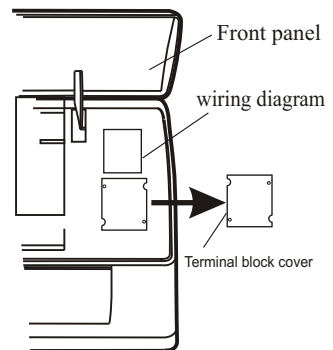
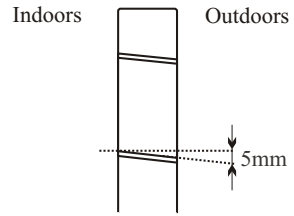
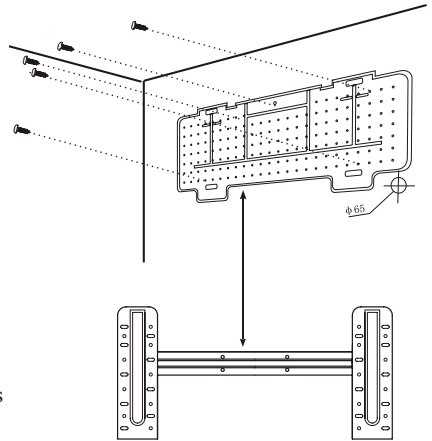

INSTALLATION MANUAL---Installation of the Indoor unit

Refrigerant piping connection

The piping can be run in the 3 directions indicated by numbers in the picture . When the piping is run in direction 1 or 3, cut a notch along the groove on the side of the indoor unit with a cutter.

Run the piping in the direction of the wall hole and bind the copper pipes , the drain pipe and the power cables together with the tape with the drain pipe at the bottom, so that water can flow freely.

- Do not remove the cap from the pipe until connecting it, to avoid dampness or dirt from entering.
- If the pipe is bent or pulled too often , it will become stiff . Do not bend the pipe more than three times at one point.
- When extending the rolled pipe, straighten the pipe by unwinding the rolled pipe, as shown in the picture.

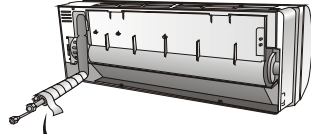
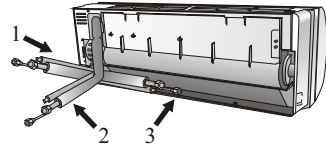

Shape the connection pipe

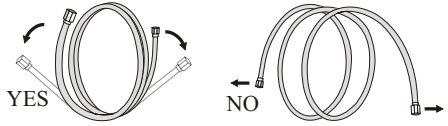

Extending the rolled pipe

Connections to the indoor unit

1. Remove the indoor unit pipe cap (check that there is no debris inside).
2. Insert the flare nut and create a flare at the extreme end of the connection pipe.
3. Tighten the connections by using two wrenches working in opposite directions.
4. For R32/R290 refrigerants, mechanical connectors should be outdoors.



Indoors Outdoors

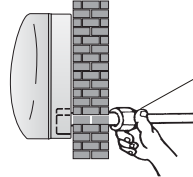

The connectors should be outdoors

Indoor unit condensed water drainage

The indoor unit condensed water drainage is fundamental for the success of the installation.

1. Place the drain hose below the piping, taking care not to create siphons.
2. The drain hose must slant downwards to aid drainage.
3. Do not bend the drain hose or leave it protruding or twisted and do not put the end of it in water . If an extension is connected to the drain hose , ensure that it is lagged when it passes into the indoor unit.
4. If the piping is installed to the right, the pipes , power cable and drain hose must be lagged and secured onto the rear of the unit with a pipe connection.
 - 1) Insert the pipe connection into the relative slot.
 - 2) Press to join the pipe connection to the base.

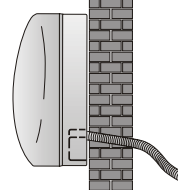

YES

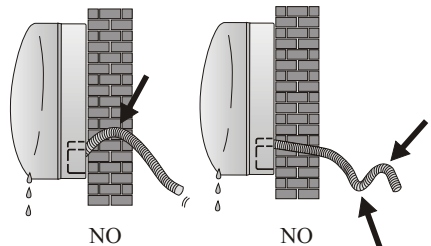

NO

NO

INSTALLATION MANUAL---Installation of the Indoor unit

INSTALLATION OF THE INDOOR UNIT

After having connected the pipe according to the instructions, install the connection cables. Now install the drain pipe. After connection, lag the pipe, cables and drain pipe with the insulating material.

1. Arrange the pipes ,cables and drain hose well.
2. Lag the pipe joints with insulating material , securing it with vinyl tape.
3. Run the bound pipe , Cables and drain pipe through the wall hole and mount the indoor unit onto the upper part of the mounting plate securely.
4. Press and push the lower part of the indoor unit tightly against the mounting plate

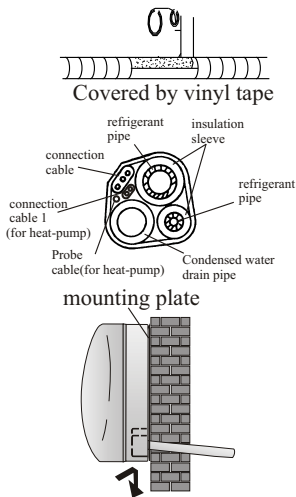

INSTALLATION MANUAL---Installation of the outdoor unit

- The outdoor unit should be installed on a solid wall and fastened securely.
- The following procedure must be observed before connecting the pipes and connecting cables : decide which is the best position on the wall and leave enough space to be able to carry out maintenance easily.
- Fasten the support to the wall using screw anchors which are particularly suited to the type of wall;
- Use a larger quantity of screw anchors than normally required for the weight they have to bear to avoid vibration during operation and remain fastened in the same position for years without the screws becoming loose.
- The unit must be installed following the national regulations.

Outdoor unit condensed water drainage (only for heat pump models)

The condensed water and the ice formed in the outdoor unit during heating operation can be drained away through the drain pipe

1. Fasten the drain port in the 25mm hole placed in the part of the unit as shown in the picture.
 2. Connect the drain port and the drain pipe.
- Pay attention that water is drained in a suitable place.

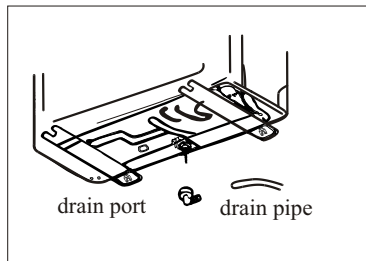

INSTALLATION MANUAL---Installation of the outdoor unit

ELECTRICAL CONNECTIONS

1. Remove the handle on the right side plate of outdoor unit.
2. Connect the power connection cord to the terminal board.
Wiring should fit that of indoor unit.
3. Fix the power connection cord with wire clamp.
4. Confirm if the wire has been fixed properly.
5. An efficient earth connection must be ensured.
6. Recover the handle.

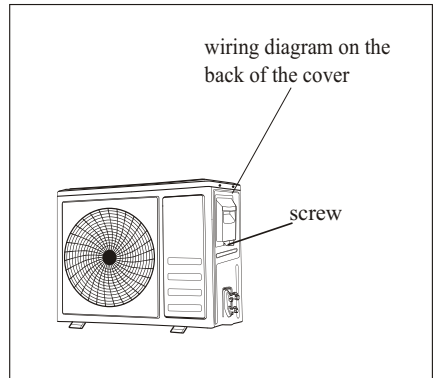

CONNECTING THE PIPES

Screw the flare nuts to the outdoor unit coupling with the same tightening procedures described for the indoor unit.

To avoid leakage, pay attention to the following points:

1. Tighten the flare nuts using two wrenches. Pay attention not to damage the pipes.
2. If the tightening torque is not sufficient, there will probably be some leakage. With excessive tightening torque there will also be some leakage, as the flange could be damaged.
3. The surest system consists in tightening the connection by using a fix wrench and a torque wrench: in this case use the table on page 29.

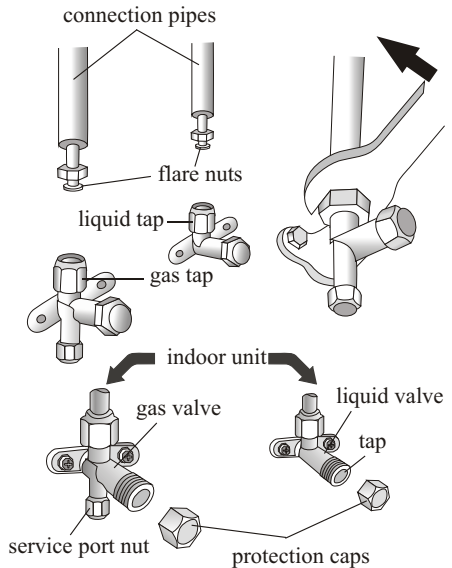

BLEEDING

Air and humidity left inside the refrigerant circuit can cause compressor malfunction. After having connected the indoor and outdoor units, bleed the air and humidity from the refrigerant circuit by using a vacuum pump.

Refrigerant Pressure Inspection

Air-returning Low-pressure Range of Refrigerant R290: 0.4-0.6Mpa; Air-exhausting High-pressure Range: 1.5-2.0Mpa;

Air-returning Low-pressure Range of Refrigerant R32: 0.8-1.2Mpa; Air-exhausting High-pressure Range: 3.2-3.7Mpa;

It means that the refrigerating system or refrigerant of an air conditioner is abnormal if the air-exhausting and air-returning pressure ranges of the detected compressor exceed the normal ranges to a large extent.

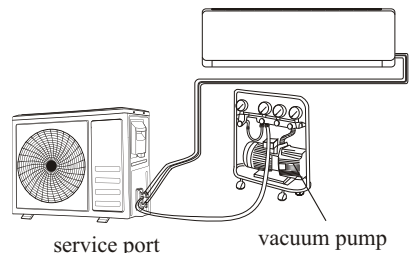

INSTALLATION MANUAL---Installation of the outdoor unit

BLEEDING

The air and humidity left inside the refrigerant circulation can cause compressor malfunction. After having connected the indoor and outdoor units, bleed the air and humidity from the refrigerant circulation using a vacuum pump.

- (1) Unscrew and remove the caps from the 2 - way and 3-way valves.
- (2) Unscrew and remove the cap from the service port.
- (3) Connect the vacuum pump hose to the service port.
- (4) Operate the vacuum pump for 10 - 15 minutes until an absolute vacuum of 10 mm Hg has been reached.
- (5) With the vacuum pump still in operation, close the low - pressure knob on the vacuum pump coupling. Stop the vacuum pump.
- (6) Open the 2 - way valve by 1/4 turn and then close it after 10 seconds. Check all the joints for leaks using liquid soap or an electronic leak device.
- (7) Turn the body of the 2-way and 3-way valves. Disconnect the vacuum pump hose.
- (8) Replace and tighten all the caps on the valves.

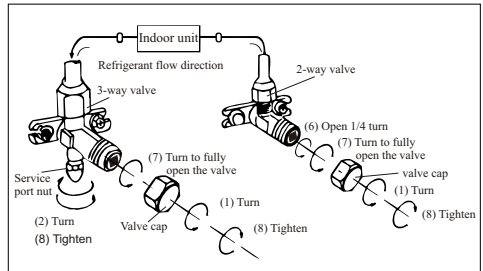
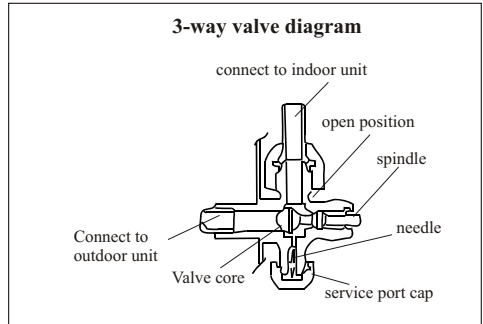

INSTALLATION MANUAL--- operation test

1. Wind insulating covering around the joints of the indoor unit and fix it with insulating tape.
2. Fix the exceeding part of the signal cable to the piping or to the outdoor unit.
3. Fix the piping to the wall (after having coated it with insulating tape) using clamps or insert them into plastic slots.
4. Seal the hole in the wall through which the piping is passed so that no air or water can fill.

Indoor unit test

- Do the ON/OFF and FAN operate normally?
- Does the MODE operate normally?
- Do the set point and TIMER function properly?
- Does each lamp light normally?
- Do the flap for air flow direction operate normally?
- Is the condensed water drained regularly?

Outdoor unit test

- Is there any abnormal noise or vibration during operation?
- Could the noise, the air flow or the condensed water drainage disturb the neighbours?
- Is there any coolant leakage?

Note: the electronic controller allows the compressor to start only three minutes after voltage has reached the system.

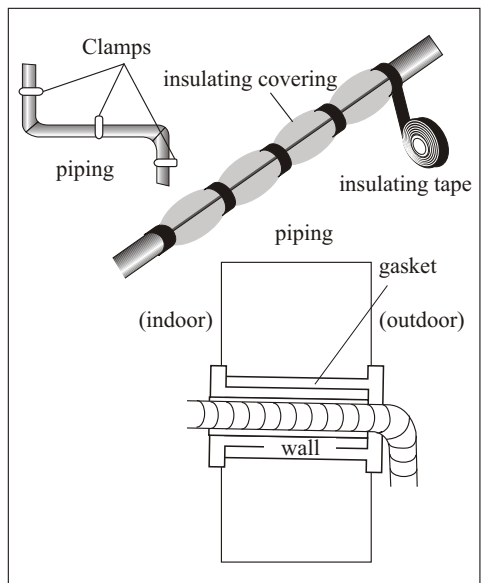

INSTALLATION MANUAL---Information for the installer

MODEL capacity (Btu/h)	9k/12k	18k/24k
Lenght of pipe with standard charge	5m	5m
Maximum distance between indoor and outdoor unit	25m	25m
Additional refrigerant charge	15g/m	25g/m
Max. diff. in level between indoor and outdoor unit	10m	10m
Type of refrigerant(1)	R32/R290	R32/R290

- (1) Refer to the data rating label sticked on the outdoor unit.
- (2) The total charge amount should under the maximum according to the table GG.1 in page 20.

TIGHTENING TORQUE FOR PROTECTION CAPS AND FLANGE CONNECTION

PIPE	TIGHTENING TORQUE [N x m]	CORRESPONDING STRESS (using a 20 cm wrench)		TIGHTENING TORQUE [N x m]
1/4 " (ϕ 6)	15 - 20	wrist strength	Service port nut	7 - 9
3/8 " (ϕ 9.52)	31 - 35	arm strength	Protection caps	25 - 30
1/2 " (ϕ 12)	35 - 45	arm strength		
5/8 " (ϕ 15.88)	75 - 80	arm strength		

INSTALLATION MANUAL---Information for the installer

WIRING DIAGRAM

For different models, the wiring diagram may be different. Please refer to the wiring diagrams pasted on the indoor unit and outdoor unit respectively.

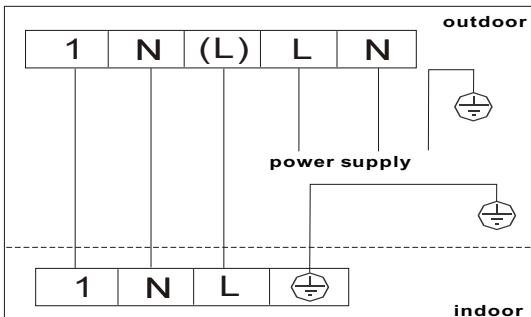
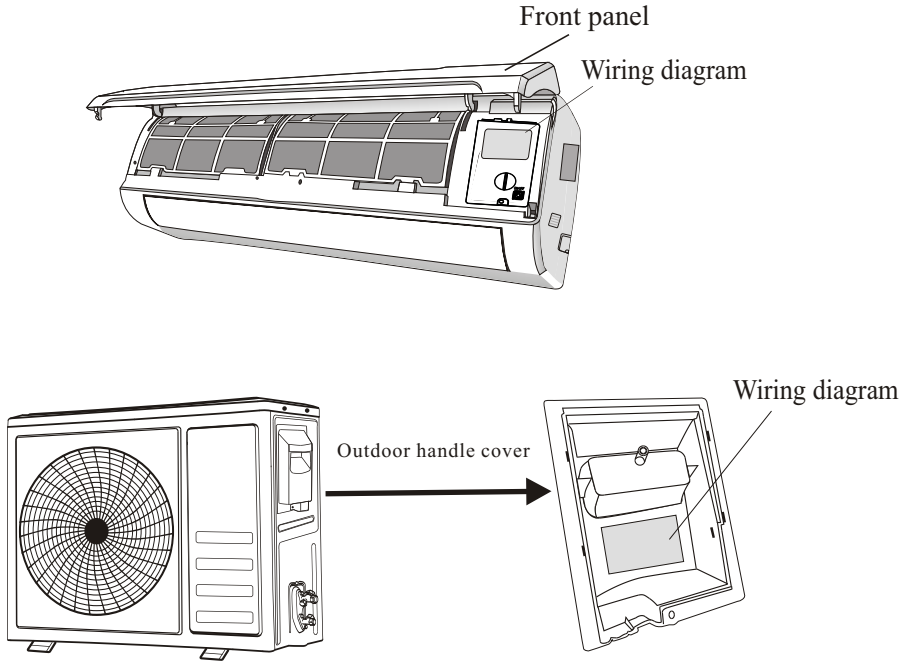

On indoor unit, the wiring diagram is pasted under the front panel;
On outdoor unit, the wiring diagram is pasted on the backside of the outdoor handle cover.



Note: For some models the wires has been connected to the main PCB of indoor unit by manufacturer without terminal block.

INSTALLATION MANUAL---Information for the installer

CABLE WIRES SPECIFICATION

INVERTER TYPE MODEL capacity (Btu/h)				9k	12k	18k	24k	
				sectional area				
Power supply cable	N			1.5mm ²	1.5mm ²	1.5mm ²	2.5mm ²	
	L			1.5mm ²	1.5mm ²	1.5mm ²	2.5mm ²	
				1.5mm ²	1.5mm ²	1.5mm ²	2.5mm ²	
Connection supply cable	N			0.75mm ²	0.75mm ²	0.75mm ²	0.75mm ²	
	(L)			0.75mm ²	0.75mm ²	0.75mm ²	0.75mm ²	
	1			0.75mm ²	0.75mm ²	0.75mm ²	0.75mm ²	
				0.75mm ²	0.75mm ²	0.75mm ²	0.75mm ²	

MAINTENANCE

Periodic maintenance is essential for keeping your air conditioner efficient.

Before carrying out any maintenance, disconnect the power supply by taking the plug out from the socket.

INDOOR UNIT

ANTIDUST FILTERS

1. Open the front panel following the direction of the arrow
2. Keeping the front panel raised with one hand, take out the air filter with the other hand
3. Clean the filter with water; if the filter is soiled with oil, it can be washed with warm water (not exceeding 45°C).
Leave to dry in a cool and dry place.
4. Keeping the front panel raised with one hand, insert the air filter with the other hand
5. Close

The electrostatic and the deodorant filter (if installed) cannot be washed or regenerated and must be replaced with new filters after every 6 months.

CLEANING THE HEAT EXCHANGER

1. Open the front panel of the unit and lift it till its greatest stroke and then unhook it from the hinges to make the cleaning easier.
2. Clean the indoor unit using a cloth with the water (not higher than 40°C) and neutral soap. Never use aggressive solvents or detergents.
3. If the outdoor unit is clogged, remove the leaves and the waste and remove the dust with air jet or a bit of water.

END OF SEASON MAINTENANCE

1. Disconnect the automatic switch or the plug.
2. Clean and replace the filters
3. On a sunny day let the conditioner work in ventilation for some hours, so that the inside of the unit can dry completely..

REPLACING THE BATTERIES

When:

- There is no confirmation beep heard from the indoor unit.
- The LCD doesn't act.

How:

- Take off the cover at back.
- Place the new batteries respecting the symbols + and -.

N.B: Use only new batteries. Remove the batteries from the remote controller when the conditioner is not in operation

WARNING! Do not throw batteries into common rubbish, they should be disposed of in the special containers situated in the collection points.

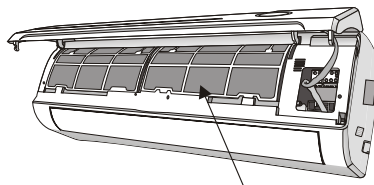
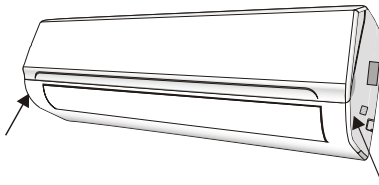

antidust filter

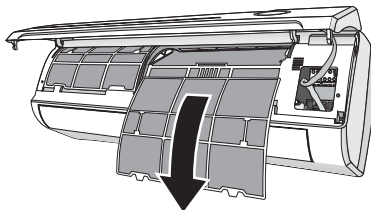

TROUBLESHOOTING

MALFUNCTION	POSSIBLE CAUSES
The appliance does not operate	Power failure/plug pulled out.
	Damaged indoor/outdoor unit fan motor.
	Faulty compressor thermomagnetic circuit breaker.
	Faulty protective device or fuses.
	Loose connections or plug pulled out.
	It sometimes stops operating to protect the appliance.
	Voltage higher or lower than the voltage range.
	Active TIMER-ON function.
Strange odor	Dirty air filter.
Noise of running water	Back flow of liquid in the refrigerant circulation.
A fine mist comes from the air outlet	This occurs when the air in the room becomes very cold, for example in the “COOLING” or “DEHUMIDIFYING/DRY” modes.
A strange noise can be heard	This noise is made by the expansion or contraction of the front panel due to variations in temperature and does not indicate a problem.
Insufficient airflow, either hot or cold	Unsuitable temperature setting.
	Obstructed air conditioner intakes and outlets.
	Dirty air filter.
	Fan speed set at minimum.
	Other sources of heat in the room.
The appliance does not respond to commands	No refrigerant.
	Remote control is not close enough to indoor unit.
	The batteries of remote control need to be replaced.
The display is off	Obstacles between remote control and signal receiver in indoor unit.
	Active LIGHT function.
Switch off the air conditioner immediately and cut off the power supply in the event of:	Power failure.
	Strange noises during operation.
	Faulty electronic control board.
	Faulty fuses or switches.
	Spraying water or objects inside the appliance.
	Overheated cables or plugs.
Very strong smells coming from the appliance.	

ERROR SIGNALS ON THE DISPLAY

In case of error, the display on the indoor unit shown the following error codes:

Display	Description of the trouble	Display	Description of the trouble
<i>E1</i>	Indoor temperature sensor fault	<i>E8</i>	Outdoor discharge temperature sensor fault
<i>E2</i>	Indoor pipe temperature sensor fault	<i>E9</i>	Outdoor IPM module fault
<i>E3</i>	Outdoor pipe temperature sensor fault	<i>EA</i>	Outdoor current detect fault
<i>E4</i>	Refrigerant system leakage or fault	<i>EE</i>	Outdoor PCB EEPROM fault
<i>E5</i>	Malfunction of indoor fan motor	<i>EF</i>	Outdoor fan motor fault
<i>E7</i>	Outdoor air temperature sensor fault	<i>EH</i>	Outdoor suction temperature sensor fault

INSTRUCTION FOR SERVICING

1. Check the information in this manual to find out the dimensions of space needed for proper installation of the device, including the minimum distances allowed compared to adjacent structures.
2. Appliance shall be installed, operated and stored in a room with a floor area larger than 4m^2 .
3. The installation of pipe-work shall be kept to a minimum.
4. The pipe-work shall be protected from physical damage, and shall not be installed in an unventilated space if the space is smaller than 4m^2 .
5. The compliance with national gas regulations shall be observed.
6. The mechanical connections shall be accessible for maintenance purposes.
7. Follow the instructions given in this manual for handling, installing, cleaning, maintaining and disposing of the refrigerant.
8. Make sure ventilation openings clear of obstruction.
9. **Notice:** *The servicing shall be performed only as recommended by the manufacturer.*
10. **Warning:** *The appliance shall be stored in a well-ventilated area where the room size corresponds to the room area as specified for operation.*
11. **Warning:** *The appliance shall be stored in a room without continuously operating open flames (for example an operating gas appliance) and ignition sources (for example an operating electric heater).*
12. The appliance shall be stored so as to prevent mechanical damage from occurring.
13. It is appropriate that anyone who is called upon to work on a refrigerant circuit should hold a valid and up-to-date certificate from an assessment authority accredited by the industry and recognizing their competence to handle refrigerants, in accordance with the assessment specification recognized in the industrial sector concerned.
Service operations should only be carried out in accordance with the recommendations of the equipment manufacturer. Maintenance and repair operations that require the assistance of other qualified persons must be conducted under the supervision of the person competent for the use of flammable refrigerants.
14. Every working procedure that affects safety means shall only be carried out by competent persons.
15. **Warning:**
 - *Do not use means to accelerate the defrosting process or to clean, other than those recommended by the manufacturer.
 - *The appliance shall be stored in a room without continuously operating ignition sources (for example: open flames, an operating gas appliance or an operating electric heater).
 - *Do not pierce or burn.
 - *Be aware that refrigerants may not contain an odour.



Caution: Risk of fire



Read operating instructions



Read technical manual

INSTRUCTION FOR SERVICING

16. Information on servicing:

1) Checks to the area

Prior to beginning work on systems containing flammable refrigerants, safety checks are necessary to ensure that the risk of ignition is minimized. For repair to the refrigerating system, the following precautions shall be complied with prior to conducting work on the system.

2) Work procedure

Work shall be undertaken under a controlled procedure so as to minimize the risk of a flammable gas or vapour being present while the work is being performed.

3) General work area

All maintenance staff and others working in the local area shall be instructed on the nature of work being carried out. Work in confined spaces shall be avoided. The area around the workspace shall be sectioned off. Ensure that the conditions within the area have been made safe by control of flammable material.

4) Checking for presence of refrigerant

The area shall be checked with an appropriate refrigerant detector prior to and during work, to ensure the technician is aware of potentially flammable atmospheres. Ensure that the leak detection equipment being used is suitable for use with flammable refrigerants, i.e. non-sparking, adequately sealed or intrinsically safe.

5) Presence of fire extinguisher

If any hot work is to be conducted on the refrigeration equipment or any associated parts, appropriate fire extinguishing equipment shall be available to hand. Have a dry powder or CO₂ fire extinguisher adjacent to the charging area.

6) No ignition sources

No person carrying out work in relation to a refrigeration system which involves exposing any pipe work shall use any sources of ignition in such a manner that it may lead to the risk of fire or explosion. All possible ignition sources, including cigarette smoking, should be kept sufficiently far away from the site of installation, repairing, removing and disposal, during which refrigerant can possibly be released to the surrounding space. Prior to work taking place, the area around the equipment is to be surveyed to make sure that there are no flammable hazards or ignition risks. "No Smoking" signs shall be displayed.

7) Ventilated area

Ensure that the area is in the open or that it is adequately ventilated before breaking into the system or conducting any hot work. A degree of ventilation shall continue during the period that the work is carried out. The ventilation should safely disperse any released refrigerant and preferably expel it externally into the atmosphere.

8) Checks to the refrigeration equipment

Where electrical components are being changed, they shall be fit for the purpose and to the correct specification. At all times the manufacturer's maintenance and service guidelines shall be followed. If in doubt consult the manufacturer's technical department for assistance. The following checks shall be applied to installations using flammable refrigerants:

--The charge size is in accordance with the room size within which the refrigerant containing parts are installed;

--The ventilation machinery and outlets are operating adequately and are not obstructed;

-- If an indirect refrigerating circuit is being used, the secondary circuit shall be checked for the presence of refrigerant;

INSTRUCTION FOR SERVICING

--Marking to the equipment continues to be visible and legible. Markings and signs that are illegible shall be corrected;

--Refrigeration pipe or components are installed in a position where they are unlikely to be exposed to any substance which may corrode refrigerant containing components, unless the components are constructed of materials which are inherently resistant to being corroded or are suitably protected against being so corroded.

9) Checks to electrical devices

Repair and maintenance to electrical components shall include initial safety checks and component inspection procedures. If a fault exists that could compromise safety, then no electrical supply shall be connected to the circuit until it is satisfactorily dealt with. If the fault cannot be corrected immediately but it is necessary to continue operation, an adequate temporary solution shall be used. This shall be reported to the owner of the equipment so all parties are advised.

Initial safety checks shall include:

--That capacitors are discharged: this shall be done in a safe manner to avoid possibility of sparking;

--That there are no live electrical components and wiring are exposed while charging, recovering or purging the system;

--That there is continuity of earth bonding.

17. Repairs to sealed components

1) During repairs to sealed components, all electrical supplies shall be disconnected from the equipment being worked upon prior to any removal of sealed covers, etc. If it is absolutely necessary to have an electrical supply to equipment during servicing, then a permanently operating form of leak detection shall be located at the most critical point to warn of a potentially hazardous situation.

2) Particular attention shall be paid to the following to ensure that by working on electrical components, the casing is not altered in such a way that the level of protection is affected. This shall include damage to cables, excessive number of connections, terminals not made to original specification, damage to seals, incorrect fitting of glands, etc.

Ensure that apparatus is mounted securely.

Ensure that seals or sealing materials have not degraded such that they no longer serve the purpose of preventing the ingress of flammable atmospheres. Replacement parts shall be in accordance with the manufacturer's specifications.

NOTE: The use of silicon sealant may inhibit the effectiveness of some types of leak detection equipment. Intrinsically safe components do not have to be isolated prior to working on them.

18. Repair to intrinsically safe components

Do not apply any permanent inductive or capacitance loads to the circuit without ensuring that this will not exceed the permissible voltage and current permitted for the equipment in use.

Intrinsically safe components are the only types that can be worked on while live in the presence of a flammable atmosphere. The test apparatus shall be at the correct rating.

Replace components only with parts specified by the manufacturer. Other parts may result in the ignition of refrigerant in the atmosphere from a leak.

INSTRUCTION FOR SERVICING

19. Cabling

Check that cabling will not be subject to wear, corrosion, excessive pressure, vibration, sharp edges or any other adverse environmental effects. The check shall also take into account the effects of aging or continual vibration from sources such as compressors or fans.

20. Detection of flammable refrigerants

Under no circumstances shall potential sources of ignition be used in the searching for or detection of refrigerant leaks. A halide torch (or any other detector using a naked flame) shall not be used.

21. Leak detection methods

The following leak detection methods are deemed acceptable for systems containing flammable refrigerants.

Electronic leak detectors shall be used to detect flammable refrigerants, but the sensitivity may not be adequate, or may need re-calibration. (Detection equipment shall be calibrated in a refrigerant-free area.) Ensure that the detector is not a potential source of ignition and is suitable for the refrigerant used. Leak detection equipment shall be set at a percentage of the LFL of the refrigerant and shall be calibrated to the refrigerant employed and the appropriate percentage of gas (25 % maximum) is confirmed.

Leak detection fluids are suitable for use with most refrigerants but the use of detergents containing chlorine shall be avoided as the chlorine may react with the refrigerant and corrode the copper pipe-work.

If a leak is suspected, all naked flames shall be removed/ extinguished.

If a leakage of refrigerant is found which requires brazing, all of the refrigerant shall be recovered from the system, or isolated (by means of shut off valves) in a part of the system remote from the leak. Oxygen free nitrogen (OFN) shall then be purged through the system both before and during the brazing process.

22. Removal and evacuation

When breaking into the refrigerant circuit to make repairs or for any other purpose conventional procedures shall be used. However, it is important that best practice is followed since flammability is a consideration. The following procedure shall be adhered to:

- Remove refrigerant;
- Purge the circuit with inert gas;
- Evacuate;
- Purge again with inert gas;
- Open the circuit by cutting or brazing.

The refrigerant charge shall be recovered into the correct recovery cylinders. The system shall be “flushed” with OFN to render the unit safe. This process may need to be repeated several times. Compressed air or oxygen shall not be used for this task.

Flushing shall be achieved by breaking the vacuum in the system with OFN and continuing to fill until the working pressure is achieved, then venting to atmosphere, and finally pulling down to vacuum. This process shall be repeated until no refrigerant is within the system. When the final OFN charge is used, the system shall be vented down to atmospheric pressure to enable work to take place. This operation is absolutely vital if brazing operations on the pipe-work are to take place.

Ensure that the outlet for the vacuum pump is not close to any ignition sources and there is ventilation available.

INSTRUCTION FOR SERVICING

23. Decommissioning

Before carrying out this procedure, it is essential that the technician is completely familiar with the equipment and all its detail. It is recommended good practice that all refrigerants are recovered safely. Prior to the task being carried out, an oil and refrigerant sample shall be taken in case analysis is required prior to re-use of reclaimed refrigerant. It is essential that electrical power is available before the task is commenced.

- a) Become familiar with the equipment and its operation.
- b) Isolate system electrically.
- c) Before attempting the procedure, ensure that:
 - . mechanical handling equipment is available, if required, for handling refrigerant cylinders;
 - . all personal protective equipment is available and being used correctly;
 - . the recovery process is supervised at all times by a competent person;
 - . recovery equipment and cylinders conform to the appropriate standards.
- d) Pump down refrigerant system, if possible.
- e) If a vacuum is not possible, make a manifold so that refrigerant can be removed from various parts of the system.
- f) Make sure that cylinder is situated on the scales before recovery takes place.
- g) Start the recovery machine and operate in accordance with manufacturer's instructions.
- h) Do not overfill cylinders. (No more than 80% volume liquid charge).
- i) Do not exceed the maximum working pressure of the cylinder, even temporarily.
- j) When the cylinders have been filled correctly and the process completed, make sure that the cylinders and the equipment are removed from site promptly and all isolation valves on the equipment are closed off.
- k) Recovered refrigerant shall not be charged into another refrigeration system unless it has been cleaned and checked.

24. Labelling

Equipment shall be labelled stating that it has been de-commissioned and emptied of refrigerant. The label shall be dated and signed. Ensure that there are labels on the equipment stating the equipment contains flammable refrigerant.

INSTRUCTION FOR SERVICING

25. Recovery

When removing refrigerant from a system, either for servicing or decommissioning, it is recommended good practice that all refrigerants are removed safely.

When transferring refrigerant into cylinders, ensure that only appropriate refrigerant recovery cylinders are employed. Ensure that the correct number of cylinders for holding the total system charge are available. All cylinders to be used are designated for the recovered refrigerant and labelled for that refrigerant (i.e. special cylinders for the recovery of refrigerant). Cylinders shall be complete with pressure-relief valve and associated shut-off valves in good working order. Empty recovery cylinders are evacuated and, if possible, cooled before recovery occurs.

The recovery equipment shall be in good working order with a set of instructions concerning the equipment that is at hand and shall be suitable for the recovery of all appropriate refrigerants including, when applicable, flammable refrigerants. In addition, a set of calibrated weighing scales shall be available and in good working order. Hoses shall be complete with leak-free disconnect couplings and in good condition. Before using the recovery machine, check that it is in satisfactory working order, has been properly maintained and that any associated electrical components are sealed to prevent ignition in the event of a refrigerant release. Consult manufacturer if in doubt.

The recovered refrigerant shall be returned to the refrigerant supplier in the correct recovery cylinder, and the relevant waste transfer note arranged. Do not mix refrigerants in recovery units and especially not in cylinders.

If compressors or compressor oils are to be removed, ensure that they have been evacuated to an acceptable level to make certain that flammable refrigerant does not remain within the lubricant. The evacuation process shall be carried out prior to returning the compressor to the suppliers. Only electric heating to the compressor body shall be employed to accelerate this process. When oil is drained from a system, it shall be carried out safely.